

Varenummer: 0125093
 Beskrivelse: Seeger låsering SP90
 Fjederstål

Mål

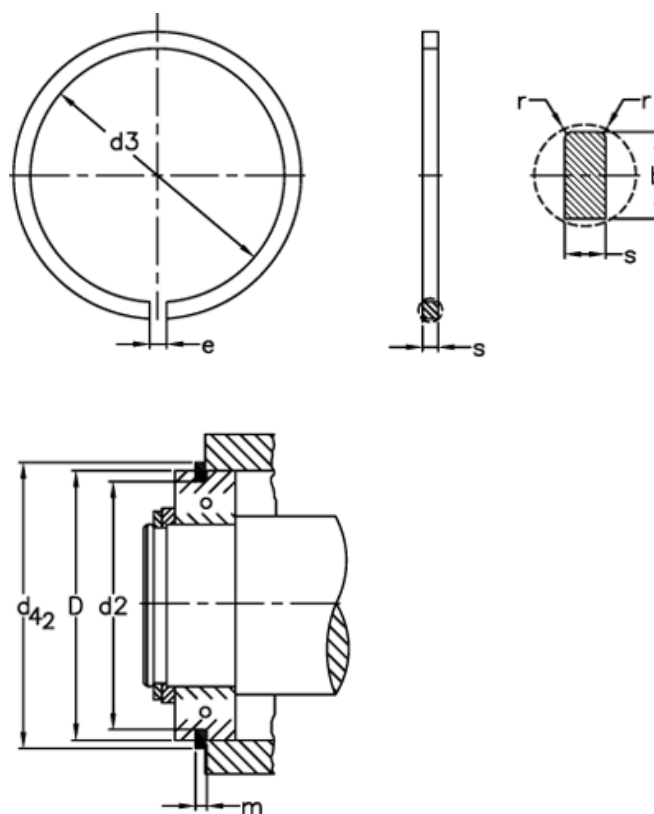

b	= 4.85	FRg kN	= 14.80	tol	= -0.15
Betegnelse	= SP 90	FR kN	= 93.9	tol	= -0.1
D	= 90	g	= 3.0	tol	= -0.50
d2	= 86.79	K kN-mm	= 174.0	tol	= 0.3
d3	= 85.4	m	= 2.70	tol	= 0.8
d42	= 96.5	n abl x 1000	= 2.0	vægt kg/1000	= 26.6
e	= 5	r min	= 0.7		
FN kN	= 74.0	s	= 2.46		